



Characteristics



- Energy saving heat pump air curtains: Up to 70% reduction in costs and CO₂ emissions (heating mode).
- Compact and low profile recessed air curtain with full grille view.
- Self-supporting casing construction made of galvanized steel plate, ready to be installed recessed in a false ceiling.
- Inlet grille (free of maintenance) made with aluminium profiles and blow-out nozzle, integrated in a single white frame colour RAL 9016. Other colours are available on request.
- EC Double-inlet centrifugal fans driven by an external rotor motor and low noise level, with very low consumption efficiency fans.
- Includes direct expansion coil with sensors. Optional condensate water pump.
- CS-5DX-NE Plug&Play control with 5 speeds and telephone cable 7m included.
- Requires DAIKIN DX Interface KIT adapted for air curtain and programmable control, please consult.
- Ready to connect to DAIKIN Inverter outdoor heat pump unit (R410A) and expansion valve not included, the customer should purchase it.

Specifications

Model	Airflow m ³ /h	Outdoor Unit 230Vx1	Outdoor Unit 400Vx3	Daikin Direct Expansion Valve	Power Fan 230V-50Hz kW	Current Fan 230V-50Hz A	Noise Level (5 m) dB(A)	Weight kg
RDAM ECM 1500 DX13-DA	2460	ERQ 100 AV1	-	EKEXV 100	0,213	1,86	57	74
RDAM ECM 2000 DX16-DA	3280	ERQ 125 AV1	ERQ 125 AW1	EKEXV 125	0,284	2,48	58	95
RDAM ECM 2000 DX18-DA	3280	ERQ 140 AV1	-	EKEXV 140	0,284	2,48	58	95
RDAM ECM 2500 DX24-DA	4100	-	ERQ 200 AW1	EKEXV 200	0,355	3,10	59	106
RDAM ECG 1000 DX10-DA	2190	ERQ 100 AV1	-	EKEXV 80	0,213	1,86	61	55
RDAM ECG 1500 DX13-DA	2920	ERQ 100 AV1	-	EKEXV 100	0,284	2,48	62	80
RDAM ECG 1500 DX15-DA	2920	ERQ 125 AV1	ERQ 125 AW1	EKEXV 125	0,284	2,48	62	80
RDAM ECG 2000 DX24-DA	4380	-	ERQ 200 AW1	EKEXV 200	0,426	3,72	63	105
RDAM ECG 2500 DX25-DA	5110	-	ERQ 200 AW1	EKEXV 200	0,497	4,34	64	114
RDAM ECG 2500 DX29-DA	5110	-	ERQ 250 AW1	EKEXV 250	0,497	4,34	64	114

DAIKIN Inverter Outdoor Units	Heating Capacity kW	Heating Power kW	SCOP or COP	Cooling Capacity kW	Cooling Power kW	SEER or EER	Power Supply	Pipes Gas Liquid inch	Pipes Minimum Length m	Pipes Maximum Length m	Pipes Maximum Height m
ERQ 100 AV1	12,5	2,74	4,56	11,2	2,81	3,99	230Vx1	5/8 3/8	-	55	35
ERQ 125 AV1	16,0	3,86	4,15	14,0	3,51	3,99	230Vx1	5/8 3/8	-	55	35
ERQ 125 AW1	16,0	4,00	4,00	14,0	3,52	3,98	400Vx3	5/8 3/8	-	55	30
ERQ 140 AV1	18,0	4,57	3,94	15,5	4,53	3,42	230Vx1	3/4 3/8	-	55	35
ERQ 200 AW1	25,0	5,56	4,50	22,4	5,22	4,29	400Vx3	3/4 3/8	-	55	30
ERQ 250 AW1	31,5	7,70	4,09	28,0	7,42	3,77	400Vx3	7/8 3/8	-	55	30

Energy efficiency: SCOP/SEER seasonal ≤12kW, COP/EER >12kW.

Outdoor unit capacities depending on standard conditions: heating 20°CDB indoor / 7°CDB and 6°CWB outdoor, cooling 27°CDB and 19°CWB indoor / 35°CDB outdoor.

When adverse weather conditions, the outdoor unit capacity can decrease. It is recommendable to oversize the units.



Characteristics



- Energy saving heat pump air curtains: Up to 70% reduction in costs and CO₂ emissions (heating mode).
- Compact and low profile recessed air curtain with full grille view.
- Self-supporting casing construction made of galvanized steel plate, ready to be installed recessed in a false ceiling.
- Inlet grille (free of maintenance) made with aluminium profiles and blow-out nozzle, integrated in a single white frame colour RAL 9016. Other colours are available on request.
- EC Double-inlet centrifugal fans driven by an external rotor motor and low noise level, with very low consumption efficiency fans.
- Includes direct expansion coil with sensors. Optional condensate water pump.
- CS-5DX-NE Plug&Play control with 5 speeds and telephone cable 7m included.
- Requires DAIKIN VRV Interface KIT adapted for air curtain and programmable control, please consult.
- Ready to connect to DAIKIN VRV outdoor heat pump unit (R410A) and expansion valve not included, the customer should purchase it.

Specifications

Model	Airflow m ³ /h	Daikin Direct Expansion Valve	Power Fan 230V-50Hz kW	Current Fan 230V-50Hz A	Noise Level (5 m) dB(A)	Weight kg
RDAM ECM 1000 VRV8-DA	1640	EKEXV 63	0,142	1,24	56	50
RDAM ECM 1500 VRV12-DA	2460	EKEXV 100	0,213	1,86	57	74
RDAM ECM 2000 VRV16-DA	3280	EKEXV 125	0,284	2,48	58	95
RDAM ECM 2000 VRV19-DA	3280	EKEXV 140	0,284	2,48	58	95
RDAM ECM 2500 VRV21-DA	4100	EKEXV 200	0,355	3,10	59	106
RDAM ECM 2500 VRV24-DA	4100	EKEXV 200	0,355	3,10	59	106
RDAM ECG 1000 VRV10-DA	2190	EKEXV 80	0,213	1,86	61	55
RDAM ECG 1500 VRV13-DA	2920	EKEXV 100	0,284	2,48	62	80
RDAM ECG 1500 VRV15-DA	2920	EKEXV 125	0,284	2,48	62	80
RDAM ECG 2000 VRV20-DA	4380	EKEXV 200	0,426	3,72	63	105
RDAM ECG 2000 VRV24-DA	4380	EKEXV 200	0,426	3,72	63	105
RDAM ECG 2500 VRV25-DA	5110	EKEXV 200	0,497	4,34	64	114
RDAM ECG 2500 VRV29-DA	5110	EKEXV 250	0,497	4,34	64	114

DAIKIN VRV compatible Outdoor Units

VRV IV HP (Heat Pump)

VRV IV HR (Heat Recovery)



When adverse weather conditions, the outdoor unit capacity can decrease. It is recommendable to oversize the units.



Dimensions

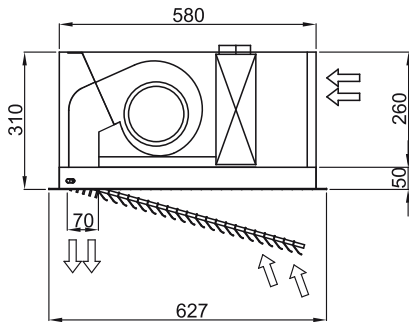
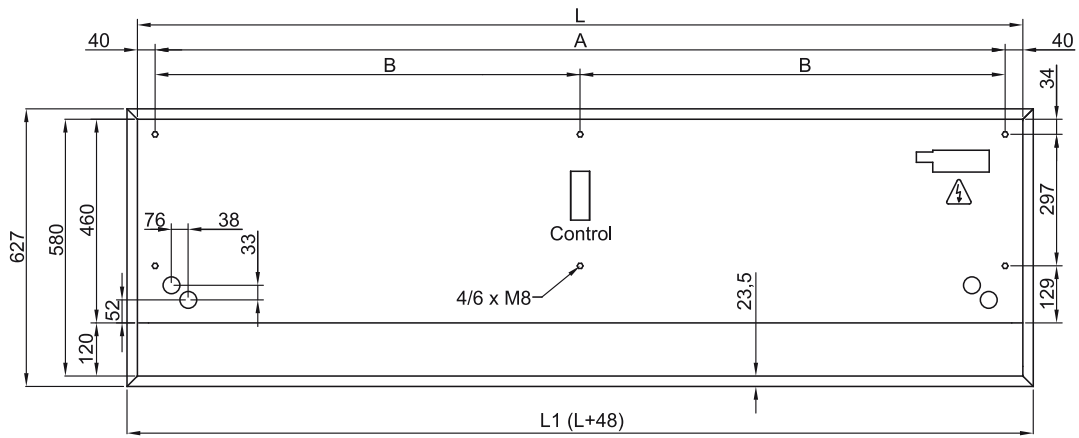

	L	L1	A	B
RDAM 1000	1000	1048	920	-
RDAM 1500	1500	1548	1420	710
RDAM 2000	2000	2048	1920	960
RDAM 2500	2500	2548	2420	1210

Finishes and details



Detail of exposed inlet grille



Customizable inlet grille in RAL color optionally